

Concrete height above steel edge  $\pm 0.040"$

Corner Lock Panel Corner Section (Full Insert)

$89^\circ +0^\circ -2^\circ$

1-1/8"

Shear Tab (Typ.)

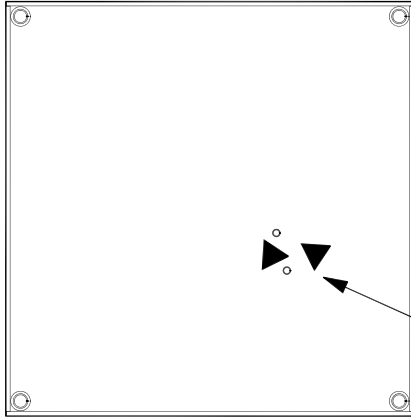

Top View

Lightweight High-strength Concrete (Bare Finish)

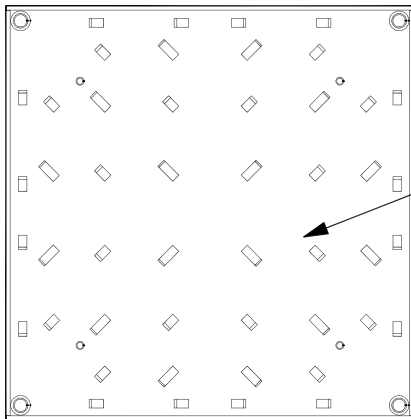

Bottom View

Galvanized Steel

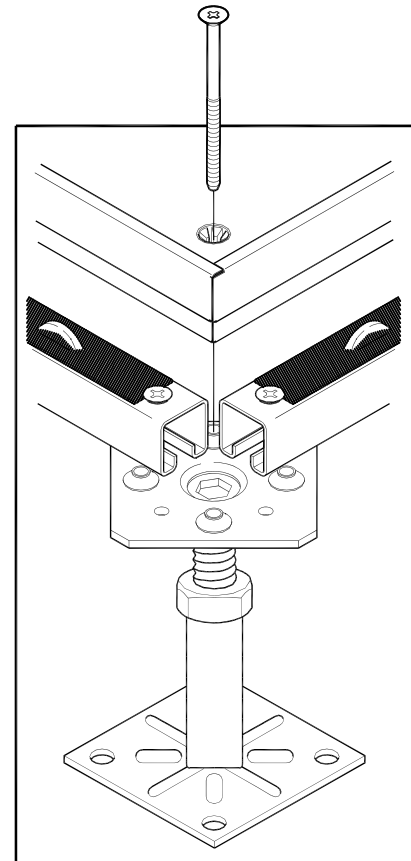

Typical Bare TecCrete Corner Lock Configuration